

# Boston

## S60 6 1/2-inch (165mm) Component Speakers

Specifications:	S60
Nominal Size	6 1/2" (165mm)
RMS Power Handling	55w
Peak Power Handling	150w
Frequency Response ( $\pm 3$ dB)	58-20kHz
Impedance	4 $\Omega$
Sensitivity (1w/1M)	92dB

#	Description	Quantity
1	Type S3 3/4" Tweeter	2
2	S60 Crossover	2
3	S60 Woofer	2
4	S60 Woofer Grille	2
5	Flush-Angle Tweeter Mount	2
6	Surface-Angle Tweeter Mount	2
7	S60 Crossover Cover	2
8	Hex Head Screw	8
9	Spring Clip	8
10	Terminated Woofer Wire	2
11	Terminated Tweeter Wire	2
12	Spring Clip-Front	2
13	Spring Clip-Rear	2
14	M4x10mm (3/8")	2
15	M3x12mm (1/2")	2
16	M4x20mm (3/4")	8
17	#6 x 3/8" Silver Socket Head Screw	4
not shown	Woofer Gasket	2
not shown	16/18AWG. Connector Barrel	8
not shown	Hex Key	1

### Woofer Dimensions

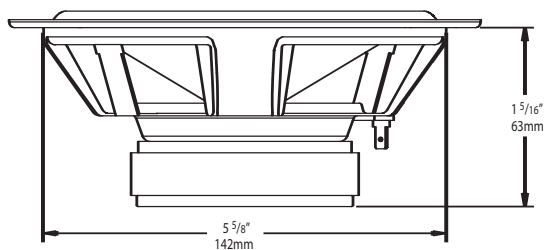

### Crossover Dimensions

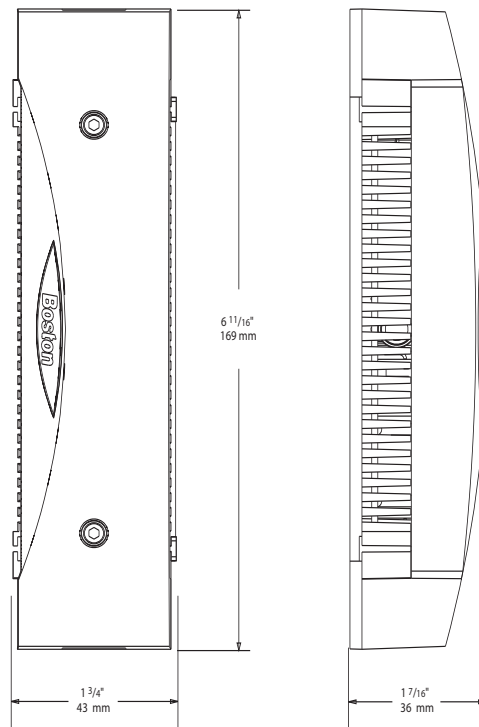

### Surface-Angle Tweeter Mount Dimensions

### Flush-Angle Tweeter Mount Dimensions

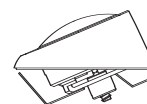
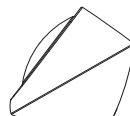
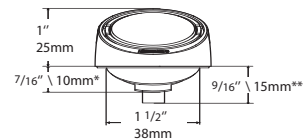
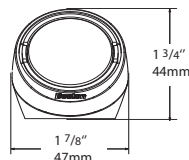
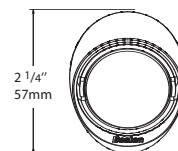
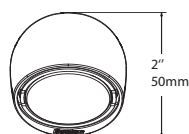

Boston Acoustics, Inc. 300 Jubilee Drive Peabody, Massachusetts 01960 U.S.A. [bostonacoustics.com](http://bostonacoustics.com)  
 © 2005 Boston Acoustics, Inc. All rights reserved. Boston, Boston Acoustics, and the Boston Acoustics logo are registered trademarks of Boston Acoustics, Inc.

042-002321-1

\* Depth Without Spring Clip  
 \*\* Depth With Spring Clip

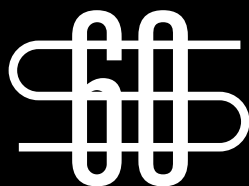

# Boston

## S60 6 1/2-inch (165mm) Component Speakers

### Surface-Angle Mount

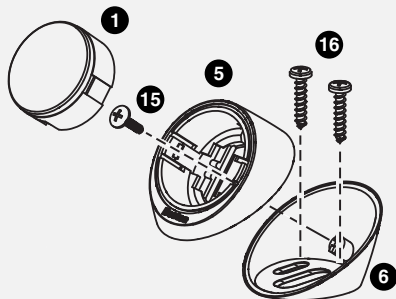

### Flush-Angle Mount

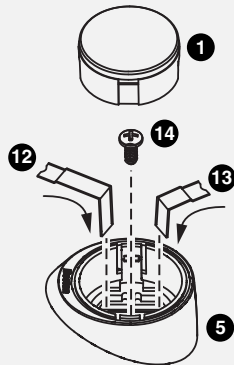

### Tweeter Level Adjustment

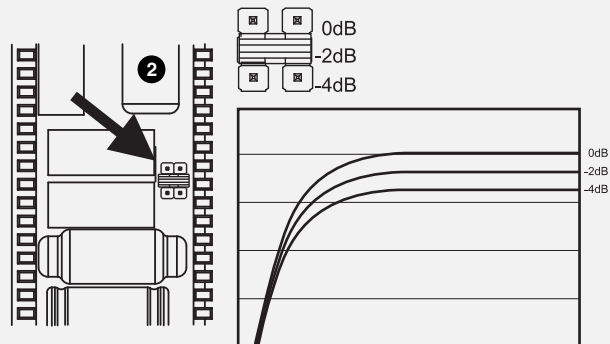

### System Wiring

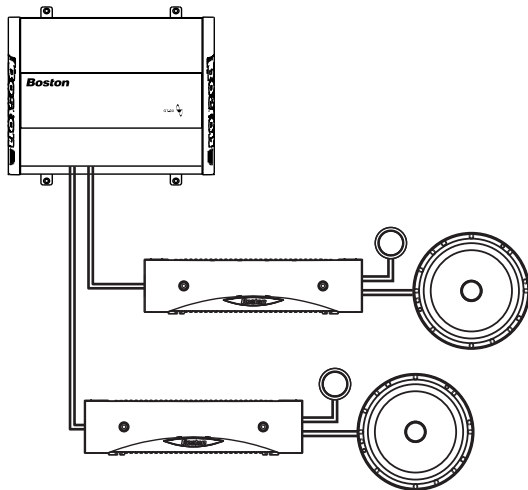

### Grille Installation

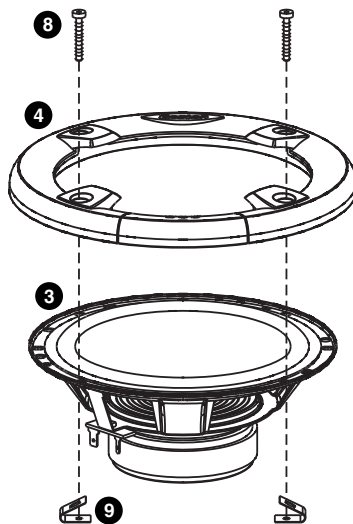

### S60 Woofer Wiring

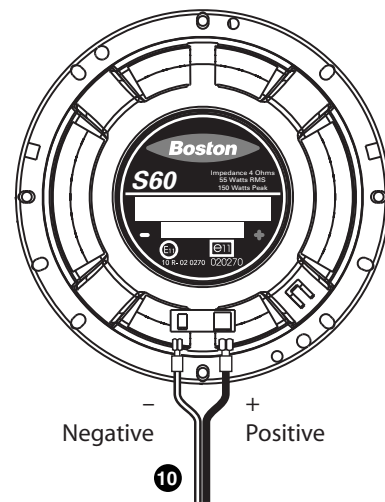

### Connecting Crossover Cases

